

TP51 SERIES

High Frequency 5.6KWatts
Planar Transformers

FEATURES

- Power Rating Up to 5600 Watts
- High Efficiency of Over 99.x%
- High Frequency 50 kHz – 200 kHz
- Footprint 80.0 mm X 53.0 mm
- Lower Profile of 21.0 mm Max
- High Isolation (operational) 5000 Vdc
- Operating Temperature -40° C to +125° C

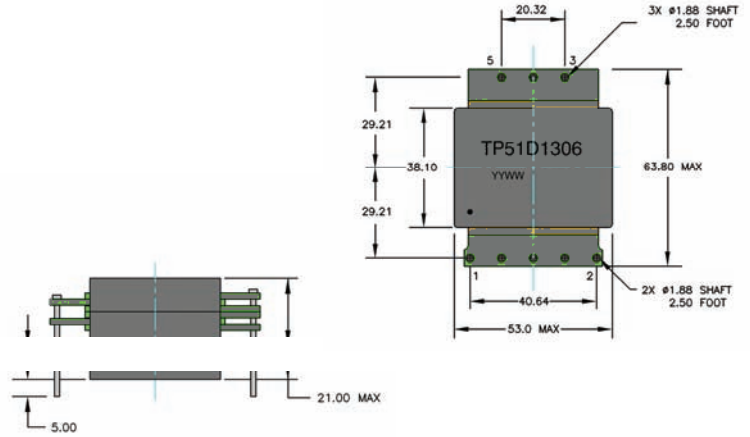

ELECTRICAL SPECIFICATIONS

Part Number	Primary ¹ Inductance (uH Min)	Leakage ² Inductance (uH Max)	DC Resistance (mΩ Max)				Turns Ratio		Pri/Sec Hi-Pot	Figure	M. Height
			Primary			Secondary	Primary	Secondary			
			A	B	AUX.						
TI5120-1R1	1.1 ± 10%	6.00	0.36			160/160	2T	26T/26T	1500Vdc	1	21.00 mm MAX.
TP51D0402	30.0	0.30	2.00			0.20	4T	2T	4000Vdc	2	
TP51D0404	30.0	0.30	0.30			0.30	4T	4T	500Vdc	3	
TP51D0804	460.0	0.40	6.00			0.30	8T	4T	4000Vdc	4	
TP51D0808	460.0	0.40	6.00			6.00	8T	8T	4000Vdc	5	
TP51D1002	760.0	0.50	10.00			0.20	10T	2T	1500Vdc	6	
TP51D0213	7.00	1.00	0.36			18.0	2T	13T	1500Vdc	7	
TP51D1306	1200	0.60	25.0			2.30	13T	6T	1500Vdc	8	

- 1.The inductance is measured in primary windings.
- 2.The leakage inductance is measured in primary windings with secondary windings shorted.
- 3.All specifications typical at T_A=25° C.

APPLICATION OF CONFIGURATION

Part Number	Vinput	Vout & Iout	Part Number	Vinput	Vout & Iout
TI5120-1R1	18 – 40 Vdc	195Vdc@10A/390Vdc@5.0A	TP51D0808	500 – 750 Vdc	200.0Vdc@30.0A
TP51D0402	125 – 165 Vdc	24.0Vdc@230.0A	TP51D1002	220 – 320 Vdc	15.0Vdc@300.0A
TP51D0404	36 – 75 Vdc	28.0Vdc@71.50A	TP51D0213	18 – 40 Vdc	200Vdc@ 10.0A
TP51D0804	125 – 165 Vdc	28.0Vdc@65.00A	TP51D1306	365 – 410 Vdc	54.6Vdc@35.0A

TP51 SERIES

High Frequency 5.6KWatts
Planar Transformers

SCHEMATICS

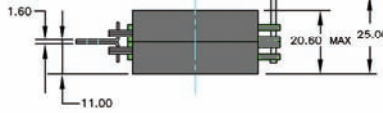
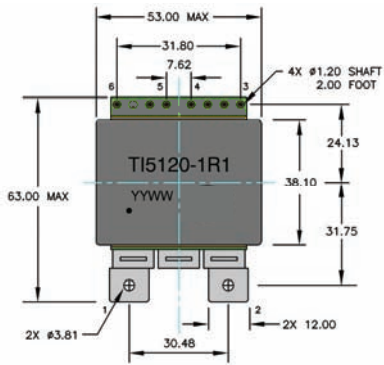
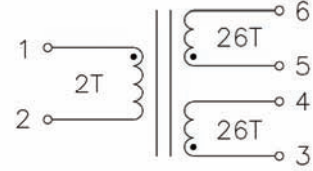

FIGURE 1



TI5120-1R1
(Flyback)

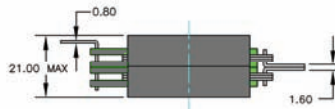
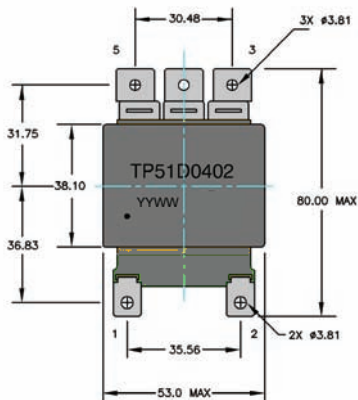
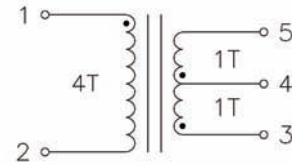

FIGURE 2



TP51D0402
(Full Bridge)

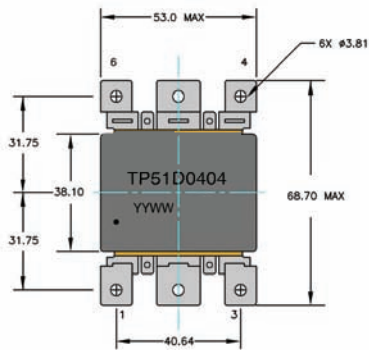
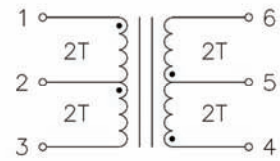

FIGURE 3



TP51D0404
(Push-Pull)

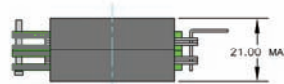
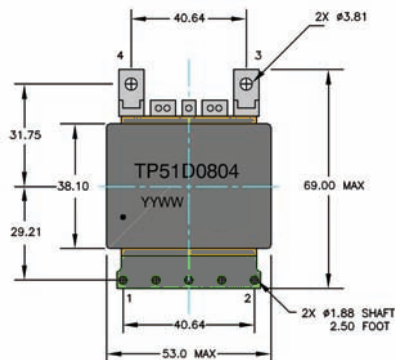
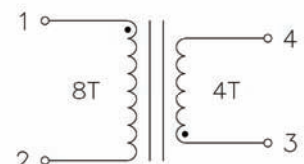

FIGURE 4



TP51D804
(Forward)

TP51 SERIES

High Frequency 5.6KWatts
Planar Transformers

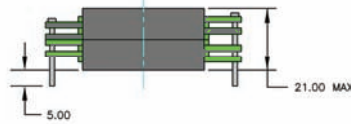
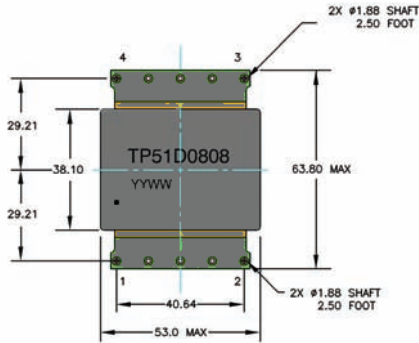
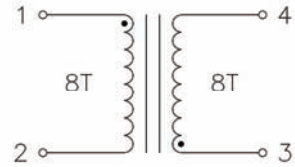

FIGURE 5



TP51D0808
(Half Bridge)

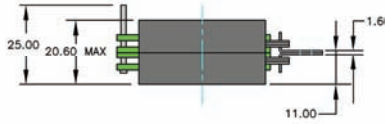
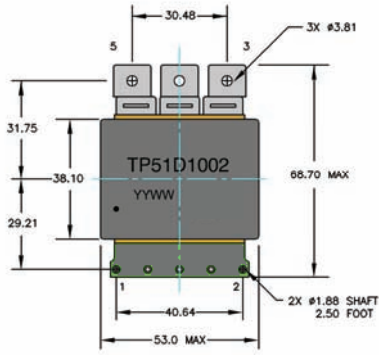
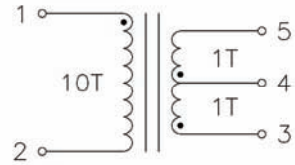

FIGURE 6



TP51D1002
(Full Bridge)

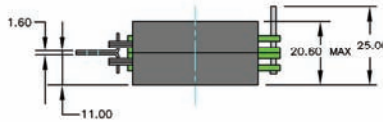
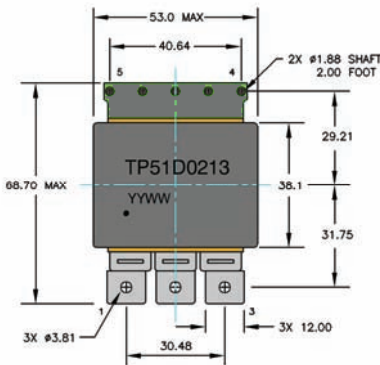
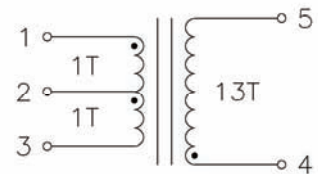

FIGURE 7



TP51D0213
(Forward)

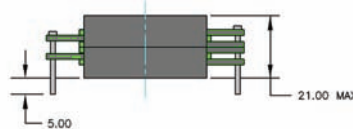
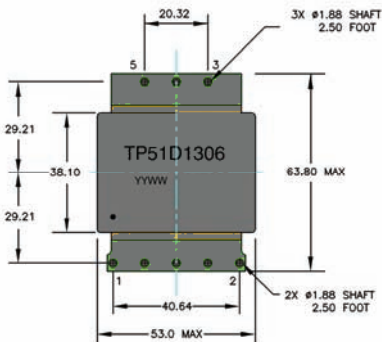
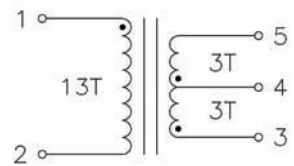

FIGURE 8



TP51D1306
(Full Bridge)